

The Robert Grossman Company

Marx Train Parts Catalog

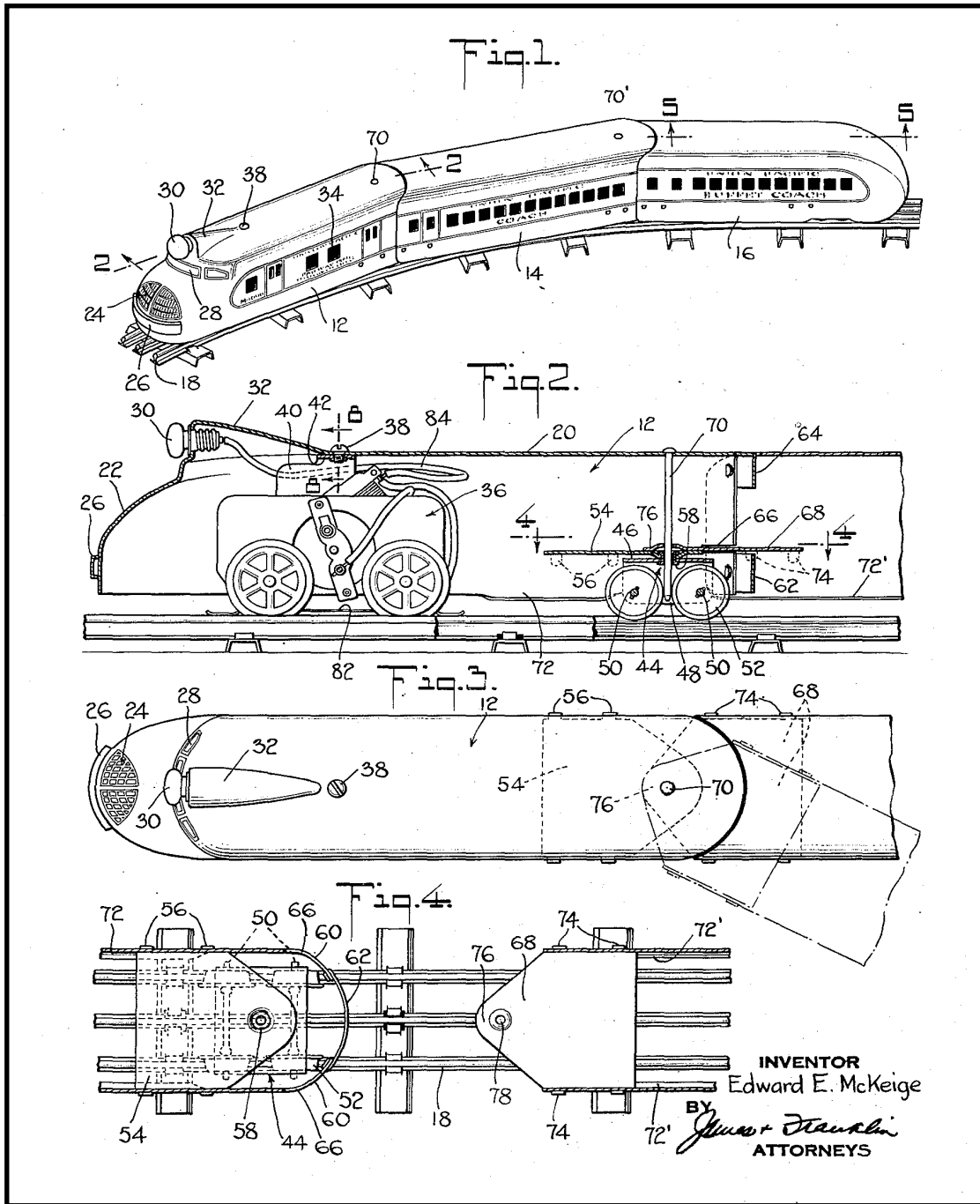

Accessories



- 348 **Metal Trim Ring** for convex lens on 436 & 410 searchlights and 6" flatcar
- 433 **Back Cover** no slots for handle
- 209 **Plastic Convex Lens** specify red or clear
- 206 **Plastic Searchlight Rim** available in black or red
- 201 **Clear Plastic Flat Lens** for searchlight
- 173 **Ground Side Accessory Terminal**
- 174 **Hot Side Accessory Terminal**
- 70 **Knurled Thumb Nut** specify brass or nickel
- 70A **Accessory Post Nut** (not shown) alternative use as a thumbnut on some accessories
- 332 **Large Thumb Nut** for 1859 150 watt transformer
- 320 **Black Control Cable & Instructions** for the 424 Radio Control Tower
- 226 **Beacon Top** *Lionel* reproduction
- 342 **429 Street Lamp Decal** Black on clear vinyl
- 259 **Headlight Visor** for *Commodore Vanderbilt*, block signals and crossing flashers. Black only
- 456 **Bulb Cover** for the 465 bubbling water tower
- 453 **Stop Sign** for the 1420 Crossing Shanty figure
- 225 **Counter Weights** for the 1420 Crossing Shanty
- 285 **Flared Lamp Socket with Leads**
- 285A **Flared Lamp Socket**
- 265 **White Plastic Crossing Gate** for the 1420 Crossing Shanty
- 382 **Lamp Socket** brass screw type with contact
- 438 **Chimney** for the 1420 crossing shanty
- 292 **Spring** for manual accessories
- X60 **Single Track Power Connector** for accessories. Used
- W60 **Double Track Power Connector** for transformer. Used

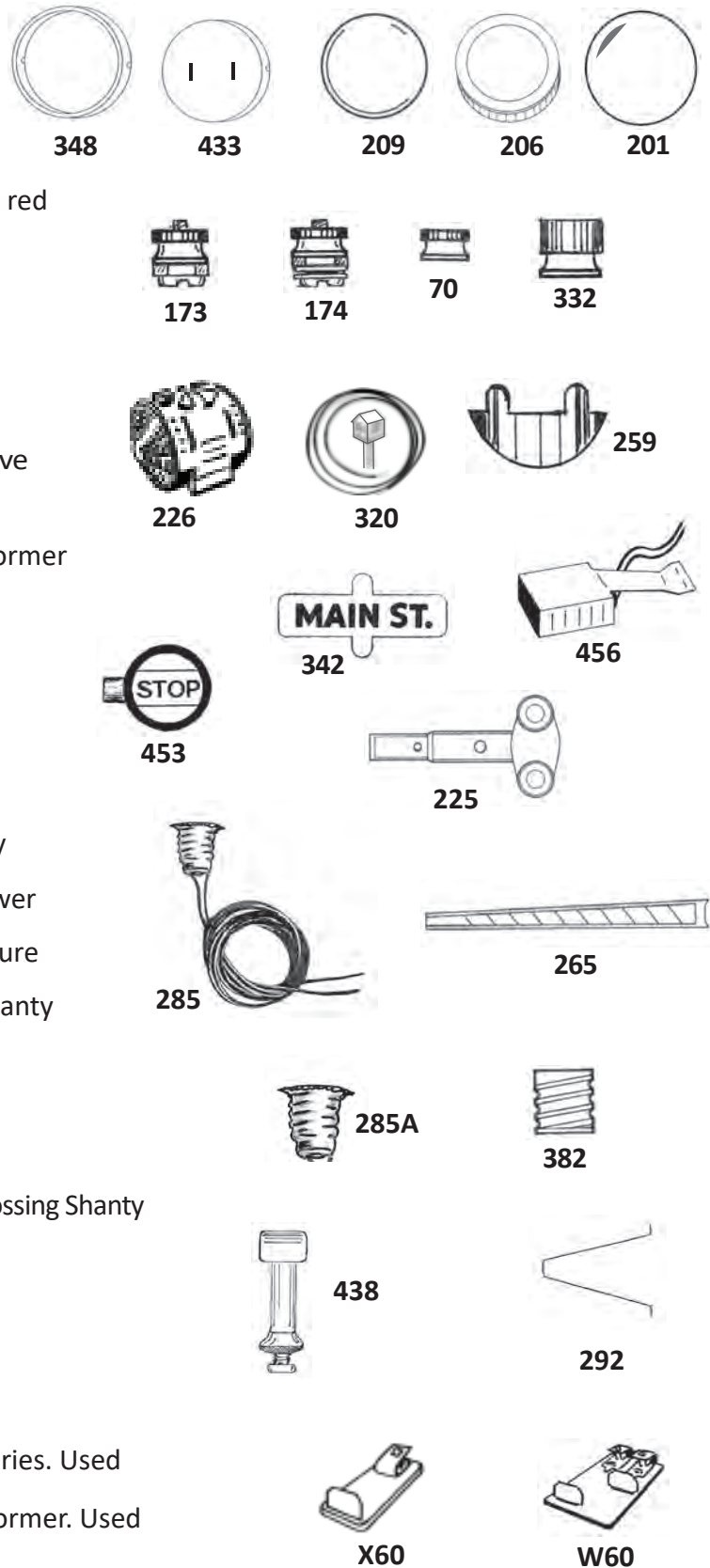

Accessories



- 141 Accessory Restoration Decals**
Self adhesive: Trim, peel and apply.
- 141A** 418 bell and 423 crossing flasher crossbuck
- 141B** 423 crossing flasher
- 141C** Block signals and circuit breakers
- 141D** 418 bell "STOP" label
- 141E** 425 Circuit Breaker
- 141F** 1405 Train Master
- 141G** Caution High Speed Trains



141A



141C



141D



141E



141B



141F



141G

- 476 "A" Nameplate** for the 434 Scale Target Signal
- 477 "74" Nameplate** for the 439 Scale Semaphore
- 478 Girard Signs** for the Girard Station
- 479 Oak Park Diesel Station Signs**
- 224 Freight Station Set** Includes 4 wooden crates and 4 barrels, used with the 5420 Freight Station
- 90 Barrel** for the 1456 barrel loader and Marxtronic set. Brown
- 298 Red Metal Barrel Ramp** for use with the 5420 Freight Station
- 230 2 Blue Plastic Figures** for the Barrel Loader
- 359 Wood Wheel** for the 2-wheel handtruck



476



477



478



224



479

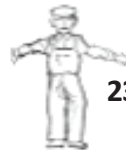

230



90



359



298

- 359 Wood Wheel** for the 2-wheel handtruck

Deluxe Vehicles

- 275** Ambulance
- 276** Fire Chief
- 277** Police Car
- 278** Taxi
- 279** Military Police Car
- 283** Military Staff Car
- Trim parts also sold separately.
- 280** Siren
- 281** Floodlight
- 282** Taxi Roof Light



275



276



277



278



279



283

MILK
MILK

140



280



281



282

- 359 Milk Van decal**

- 234 Play Set Vehicle** with colored wheel sets. Specify auto or panel truck, random colors. For "black wheeled" vehicles, see **LOADS** section of catalog.



234 (Panel Truck)

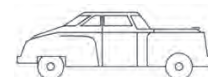

234 (Auto)

Accessories



- 299 **Billboard Lamp Plate** Use a high voltage lightbulb for lower heat
- 366 **Billboard Insert** 2 color, non original
- 300 **Billboard Insert** "Don't Ever Forget to Have Fun!"
- 301 **Billboard Insert** Repro of Crosley TV ad
- 302 **Billboard Insert** Repro of Halo Shampoo



- 368 **1 1/2" Long Accessory Rail Clip** for momentary contact such as bells and flashers. Press ends together before placing on track



- 330 **027 Lionel Track pins** dz.

330



- 355 **Red Lens** for the 1610 metal illuminated switch



- 356 **Green Lens** for the 1610 metal illuminated switch

- 31 **Flag** for the 313 low clearance hazard telltale bend curves before installing

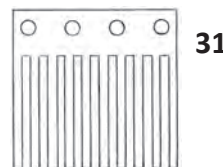

- 443 **Large Red Plastic Reflector** used on 067 plastic crossing signals

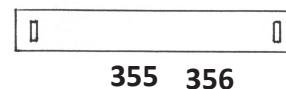

- 446 **1350 Open Truss Bridge Decals** sold in pairs

Illinois Central Rock Island
New York Central Wabash
Baltimore & Ohio Monon
Santa Fe



446



196

Handcar Parts

- 196 **Plastic Railroad Man** with painted hands & face: specify blue or gray

- 168 **Handcar Brush Spring**

- 169 **Handcar Brush**

- 198 **Crossbeam** cast metal

- 274 **Plastic Arms** painted hands: specify blue or gray

- 199 **Crossbeam Center Pin**

- 203 **Connecting Pin** hole in push rod must be enlarged to 3/32"



169 Brush

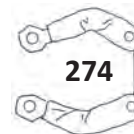

274

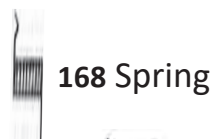

168 Spring



199



198

Accessories

- 129 Transformer Power Cord
- 457 Wood Handle for the 1409 transformer
- 180 Schedule Board for the Plastic Railroad Station
- 228 Replacment Spring for the track uncoupler plate
- 287 Globe for the 074 boulevard lamp post
- 454 Colored Acetate Lens Set for the 439 semaphore, tape behind openings
- 165 Lamp Post for the Illuminated Girard whistling station, Oak Park, and Lighted Gateman
- 269 5 Amp Circuit Breaker for safe use of early transformers that do not have internal circuit breakers
- 270 Large Chimney for the Glendale station, painted red
- 398 Roof for the 413A switchman's tower
- 401 Lamp Cover for the prewar automatic uncoupler
- 402 Chimney for the Girard whistling station, painted red
- 267 Spout for the 065 water tower, specify black or gray
- 414 PRR 1340 Foot Bridge Self Adhesive Decals
- 415 PRR 1305 Metal Bridge Self Adhesive Decals
- 417 Lamp Socket with base and terminals for illuminating buildings
- 419 Stair Support for the 2940 plastic switchman's tower
- 424 Plastic Ladder for the 065 water tower: specify gray, black, cream, or red
- 464 Cone Shaped Top for the 464 Plastic Block Signal: specify gray or black
- 426 Three Color Electric Switch Wire red, green, and black
- 319 Black Transformer to Switch Controller Wire Lead Soldered ends

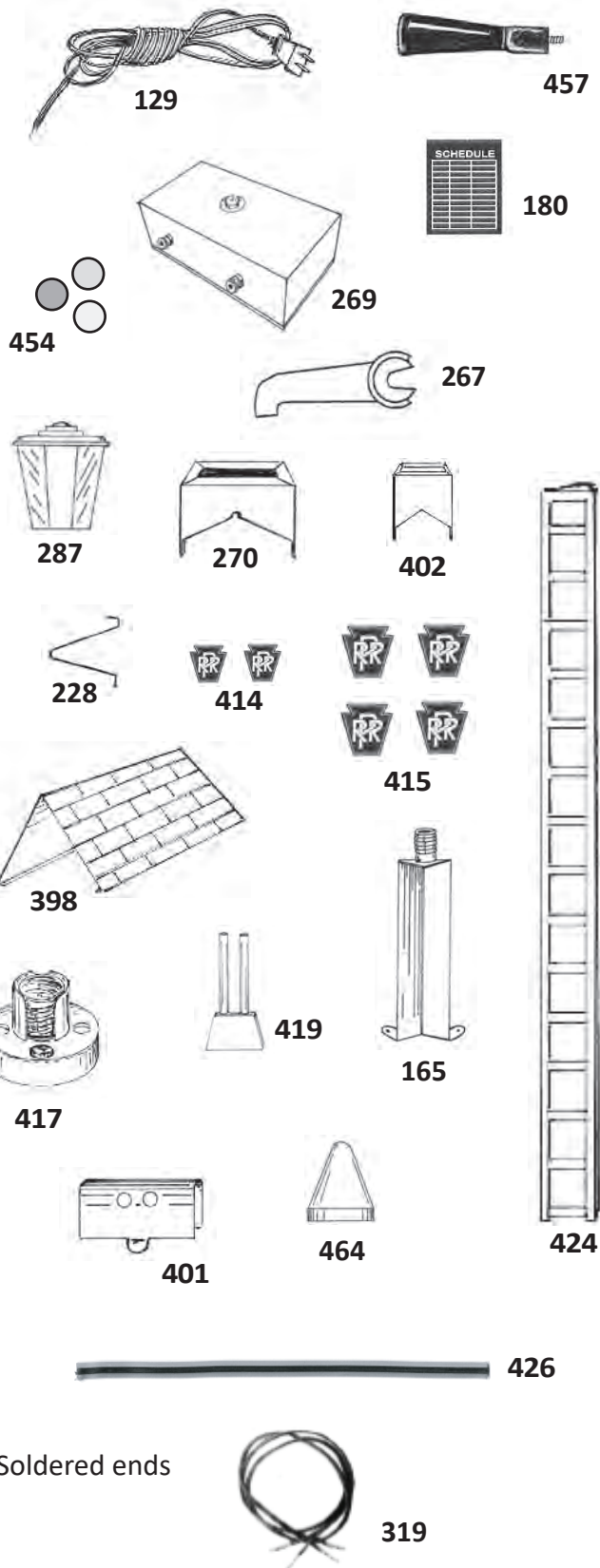

Diesel Engines



- 470 GE 70 Ton Switcher Handrail Set
- 27 Plastic E-7 and GE 70 Ton Diesel Horn specify black or silver
- 27A Narrow Base Horn for metal diesels
- 28 Red Plastic Horn for the 1789 Cape Canaveral switcher
- 29 Black 1998 S-3 Diesel Horn
- 53 Plastic E-7 Diesel Motor Truck Side Frame specify black or silver
- 54 1998 S-3 Truck Side Frame sold in pairs (L & R) Specify black or silver
- 56 1998 S-3 Beveled Brass Truck Mounting Spacer
- 69 Diesel Step specify green, silver, orange or PC green
- 132 Diesel Lamp Plate for plastic E-7
- 63 Diesel Lamp Plate for metal 62 / 6000
- 125 Dog Bone Connector for the M10005 power car & dummy unit
- 191 Long Motor Plate Spacer to prevent plate collapse when installing side frames
- 192 Short Motor Side Frame Spacer for the gear side
- 193 Plastic E-7 Top Motor Mount Brass Spacer
- 196 Metal Motor Mount Bracket convert an electric single reduction motor to a suspension motor in an M10000. Includes instructions & screws
- 205 Headlight Lens specify red or clear
- 139 Rubber Traction Tire for grooved diesel wheel
- 329 Large Top Washer for 62 & 6000 top motor mount
- 337 Diesel Wheels call for price and availability
- 429 E-7 Motor Mount Plate Plugs (4) epoxy in place
- 430 M10005 Wheel Set also used on metal FM diesels. Used
- 437 Extra Long Axle for M10005 and FM diesels
- 474 Motor Support Plate for the 21 Diesel
- 475 Short Tab & Slot Coupler used on the 21, E-7 Powered A & some 62/6000 Diesels
- 486 E-7 Motor Mounting Plate with electrical clip
- 487 21 Diesel Lamp Plate

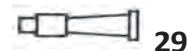
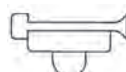

27 27A 28

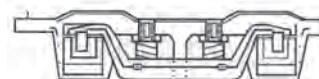

54

53



56



69



63



132

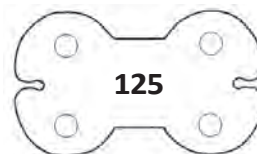

125



196



191



192



193

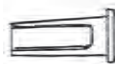

205



139

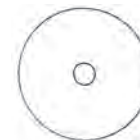

329

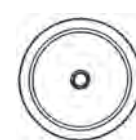

337



429

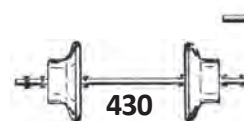

430



437



475



474



486



487

Fasteners



Eyelets There are multiple applications for each eyelet. The following are the most common ways of using them. Measure or assemble the parts and add 1/16" for rollover.

- 323** Shorter eyelet for thinner metals (dz)
- 324** Tab and slot couplers to 6" frames and trucks to metal frames (dz)
- 17** Plastic knuckle couplers and 6" car frames (dz)
- 410** *Type A* trucks to metal frame & 1420 counterweights (dz)
- 71** Plastic knuckle couplers & 4 wheel plastic cars (dz)
- 345** Plastic cars with knuckle couplers & *Type G* trucks (dz)

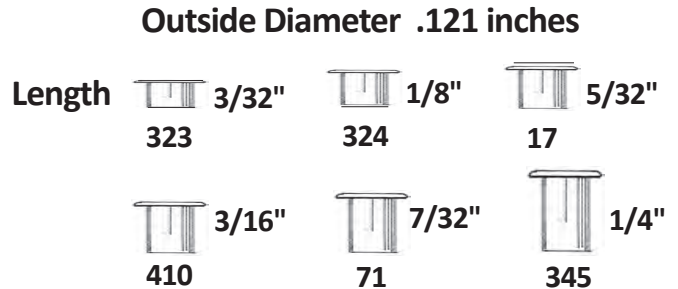

- 328** Switch repair & load stakes on 6" cars (dz)
- 397** Prewar 3 piece pickup (dz)
- 325** Lamp socket to wire (dz)

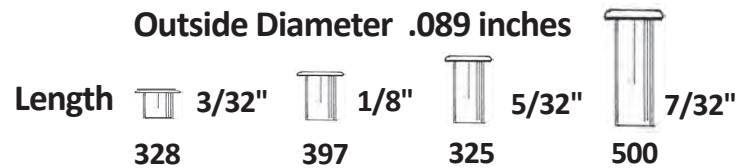

- 322** *M10000* truck to frame (dz)
- 24** Nickel eyelet for E-7 side frames (ea)
- 354** 6" wrecker crane car (ea)
- 500** Pre-war manual reverse plates (dz)

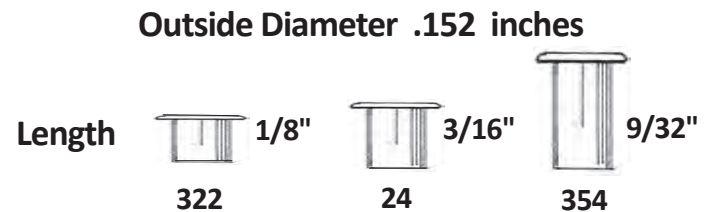





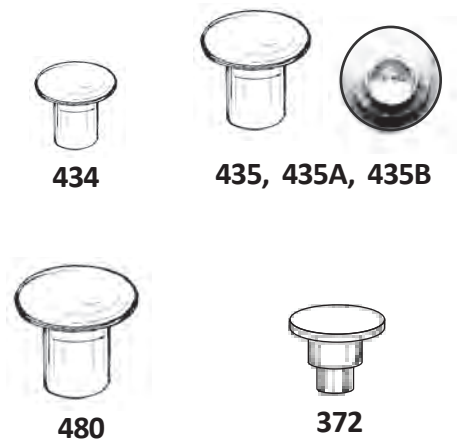























Tubular Solid Rivets

- 434** Log dump car main spring & *Wm Crooks* smoke units
- 435** Side rod links on 333/1829 steam engines. Rivets will vary in size depending on what is currently available. Fitting will be required generally using a #43 drill (.089)
- 435A** 333/1829 forward steam chest side rod to the slide
- 435B** To re-assemble the 429 Main Street street lamp
- 480** Shoulder Rivet for attaching automatic boxcar levers
- 372** Shoulder Rivet for the 333/1829 front side rod slide



Eyelet sampler pack available containing most commonly used eyelets. Please call to order.

Fasteners

148A	Motor Mount Screw	1/8" metal steam engine w/ straight rods				
148B	Motor Mount Screw	3/16" 666/1666 & some brush plates	148A	148B	148C	148D
148C	Motor Mount Screw	1/4" engine with steam chest				
148D	Motor Mount Screw	3/8" steam chest with weight				
52	Motor Mount Screw	Oval head 333/1829 & other plastic steam engines				
373	Motor Mount Screw	Sheet metal screw for steam engines & 70 ton switcher		52	373	
335	Motor Mount Screw	E-7 diesel top motor mount screw				
49	Motor Mount Screw	1998 Alco S-3 diesel motor mount & truck screw				
				335	49	
46	Side Rod Eccentric Crank Screw	for 333/1829 steam engines				
47	Brass Shoulder Bolt	for 999 & 666 rear trucks				
48	Brass Shoulder Bolt	for 333/1829 front & rear trucks				
50	Top Motor Mount Shoulder Bolt	for 6000 <i>Santa Fe</i> & 62 <i>B&O</i> metal diesels				
73	Fahnestock Wire Clip	used on motor terminals & accessories (ea)	46	47, 48	50	
75	Washers	for extra clearance under a diesel side frame. (pr)				
78	Brush Plate Screw					
145	Diesel Side Frame Nut & Screw.	Cast weight motors may require fitting of side frames				
				73		
146	Small Phillips Head Brush Plate Screw					
147	Twist Rivet	for 1666 rear truck				
149	Gear Cluster Retainer		145	146	147	149
150	Body Screw	for plastic freight cars				
151	Short Body Screw	for plastic slope back tenders				
155	Boiler Front Screw	for 333 & 666/1666 steam engines				
179	Hex Head Main Side Rod Bolt	for 333/1829 engines				
182	Hand Rail Cotter Pin					
183	Narrow Hand Rail Cotter Pin	for 333 engines & 333/1829 tenders	150	151	155	179
217	Electric Motor Nut	for brush plates				
217A	Electric Motor Nut Large Pattern.	Used on some brush plates				
308	Socket Head Screw	fits threaded 333 cranks. Not a shoulder bolt. Use a tiny amount of <i>Loctite</i> before assembly	182	183		
314	Tiny Lock Washer	used under the 410, 436 metal floodlight				
315	Nut	for the original shoulder rivet used on the 611 trestle elevator			217	308
316	Black Button Head Nut & Bolt	for the 611 trestle elevator				
331	Girard & Oak Park Station Roof Screw					
394	333 Armature Washer					
492	Top Motor Mount Shoulder Bolt	for the <i>M10000</i>	314	315	316	331

HO Parts



- 177 HO Load Tie Down specify boat load, lumber load or cable reels
- 190 HO Caboose Stack post is a bit large for the hole; either file to fit or enlarge the hole in the roof
- 290 New Old Stock Hong Kong HO Truck brass axles with pointed ends on wheelsets
- 374 New Old Stock HO Wheel Set
- 375 New Old Stock HO Truck
- 379 New Old Stock NMRA Type Coupler
- 383 New Old Stock Hong Kong Knuckle Coupler used with battery sets
- 451 Rectangular HO Wood Load for 6128 & 6130 flat cars
- 452 HO Log Load for 6028 Erie Log dump cars



177



374



190



290, 375

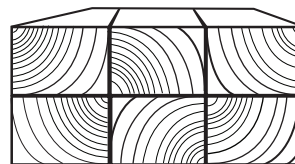

451



379



452

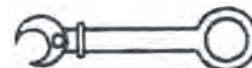



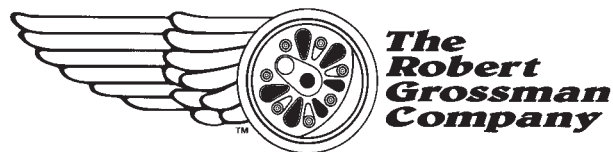
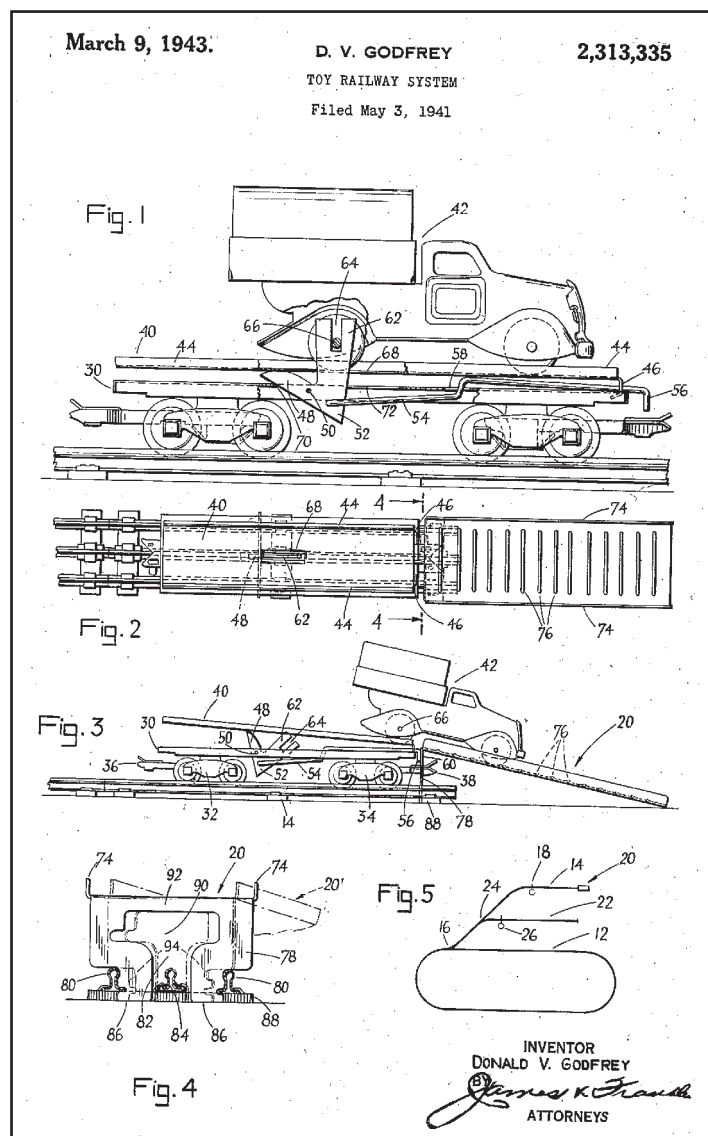











383



www.trainpartsformarx.com

Serving the Marx model railroading community since 1992

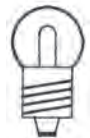
Bulbs

- | | |
|---|---|
| <p>92 14V Clear Large Globe general purpose, engines, rolling stock & accessories</p> <p>92A 12.5V Original Type Large Globe clear bulb</p> <p>93 14V Clear Small Globe general purpose, used where clearance may be a concern</p> <p>93A 12.5V Original Type Small Globe clear bulb</p> <p>95 18V Red Large Globe block signals & crossing flashers</p> <p>96 18V Green Large Globe block signals</p> <p>97 18V Amber Large Globe block signals</p> <p>98 18V Red Small Globe crossing flashers & block signals</p> <p>99 18V Green Small Globe block signals</p> <p>100 18V Amber Small Globe block signals</p> <p>101 1.1V Clear Button Shaped Small Globe for battery operated engines</p> <p>102 18V Frosted Extra Large Globe for street lamps</p> <p>103 14V Red Large Globe Blinker for constant blinking crossing flashers</p> <p>104 14V Clear Large Globe Dimple Bulb for revolving beacon tower</p> <p>166 14V Clear Button Shape Bulb for early engines & accessories</p> <p>166R 14V Red Button Shaped Bulb for early block signals & crossing flashers</p> <p>166A 14V Amber Button Shaped Bulb for early block signals</p> <p>166G 14V Green Button Shaped Bulb for early block signals</p> <p>200 18V Clear Small Globe for use where heat may be a concern</p> <p>232 18V Clear Large Globe</p> <p>258 14V Frosted Pattern Bulb for engines with exposed bulbs</p> <p>261 18V Miniature Clear Tubular Globe <i>Wm Crooks</i> & 1438 crossing gate</p> <p>381 6-8V Clear Small Globe for a brighter metal steam engine headlight</p> <p>461 14V Miniature Red Bulb for the 1426 plastic banjo signal</p> |  <p>92, 92A</p>  <p>93, 93A</p>  <p>95, 96, 97</p>  <p>98, 99, 100</p>
 <p>101</p>  <p>102</p>  <p>103</p>  <p>104</p>
 <p>166</p>  <p>200</p>  <p>232</p>  <p>258</p>
 <p>261</p>  <p>381</p>  <p>461</p> |
|---|---|



Here's a bright idea!
Order your parts today at www.trainpartsformarx.com

Motor Parts



Electric Motors

14 **Carbon Brush** exact size of the original factory brushes



14



15



51

15 **Brush Spring** fits all motors except early tubular brush plates & handcars

51 **Brush Spring** for early tubular brush plates

449 **Carbon Brush** early type fits tubular brush plates & Joy Line



449



57



62

57 **Pickup Spring** for postwar single collector pickup

62 **Red Interior Smoke Stack** for 333/1829 smoke units

212 **666/1666 Smoke Unit Top Insert**



212

164 **30 Tooth Single Reduction Idler Gear** for deluxe 4 wheel motors
Self lubricating, black nylon

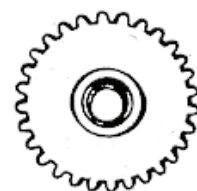

164, 164A

164A **30 Tooth Single Redution Idler Gear** brass

370 **Front Truck Mount** for 666/1666 motors



370

468 **New 32/12 Tooth Compound Gear** (.170 shaft size) used on E-7 & 1998 engines

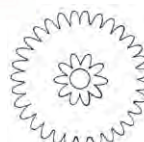

468

172 **Felt Oil Wick** for the brush plate armature shaft



172

202 **Replacement Smoke Element** to install, pry sides of housing apart, slip on wick sleeve and insulate one side of wire, other side is a ground. Use high temperature sealant and reassemble housing. Crimp over stud tabs to secure.

305 **Nylon Smoke Unit Piston & Pin** used in the 1666 steam chest smoke units, *Wm Crooks*, and the 6096 HO *Hudson*



202

297 **Smoke Unit Bottom Slide** 666/1666

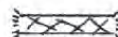

297

243 **Complete Postwar Pickup** good used condition

207 **Postwar Pickup Insulator Plate** with brass center post



305

494 **Rear Motor Mounting Plate** for the 1829 engine (*not shown*)
Other types available. Call for availability



207

*Used, serviced motors available.
Call for price and availability.*

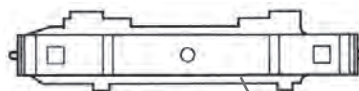

243

Motor Parts

Electric Motors

- 21 Prewar Axle Bearing with slot
- 248 Postwar Axle Bushing .140 (common size)
some early postwar axles are .135 which will not be a tight fit
- 391 Prewar Pickup Shoe hard bronze
- 444 Postwar Axle plain, must be splined
- 442 Prewar Axle plain, must be splined
- 471 Used Armature 10 tooth gear cleaned, turned and tested. Specify nylon or bronze bushing
- 496 Reversing Unit rebuilt, serviced and tested
Specify engine application (not pictured)
- 496R Reversing Unit Rocker Assembly (not pictured)

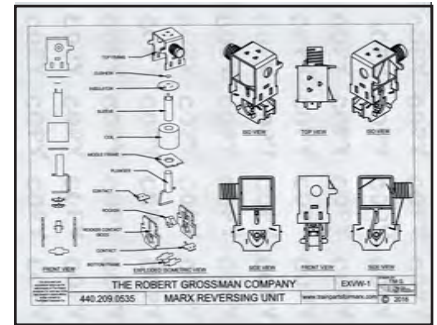

EXVW-1

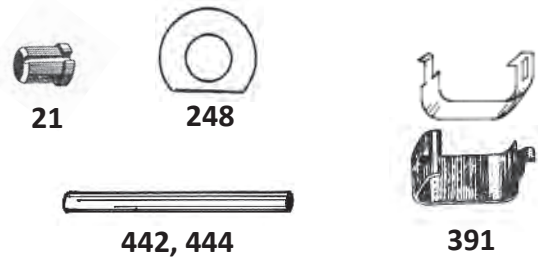

EXVW-1 Exploded View of the Marx Reversing Unit

Call for brush plates, reversing units, field coils, axles, gears, drivers, motor mounts, and pre-war pick-up assemblies.

Mechanical Wind-Up Motors

- 30 Clockwork Key square stock
- 30A Threaded Clockwork Key for early engines, round stock
- 118 Bell Spring
- 138 Flint for the sparkler plate
- 194 Metal Sparkler Plate with flint

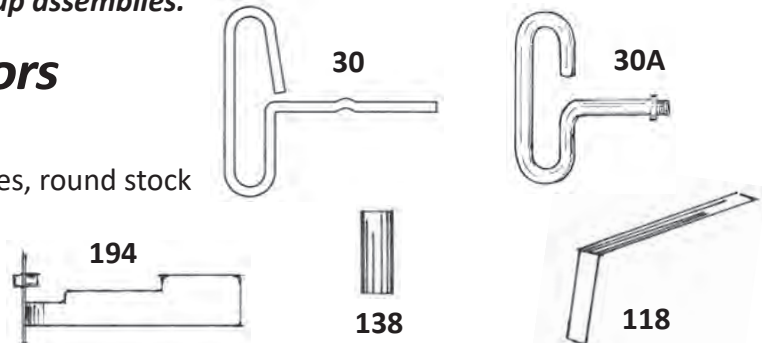

Schematic Wiring Diagrams for Marx O Gauge Motors

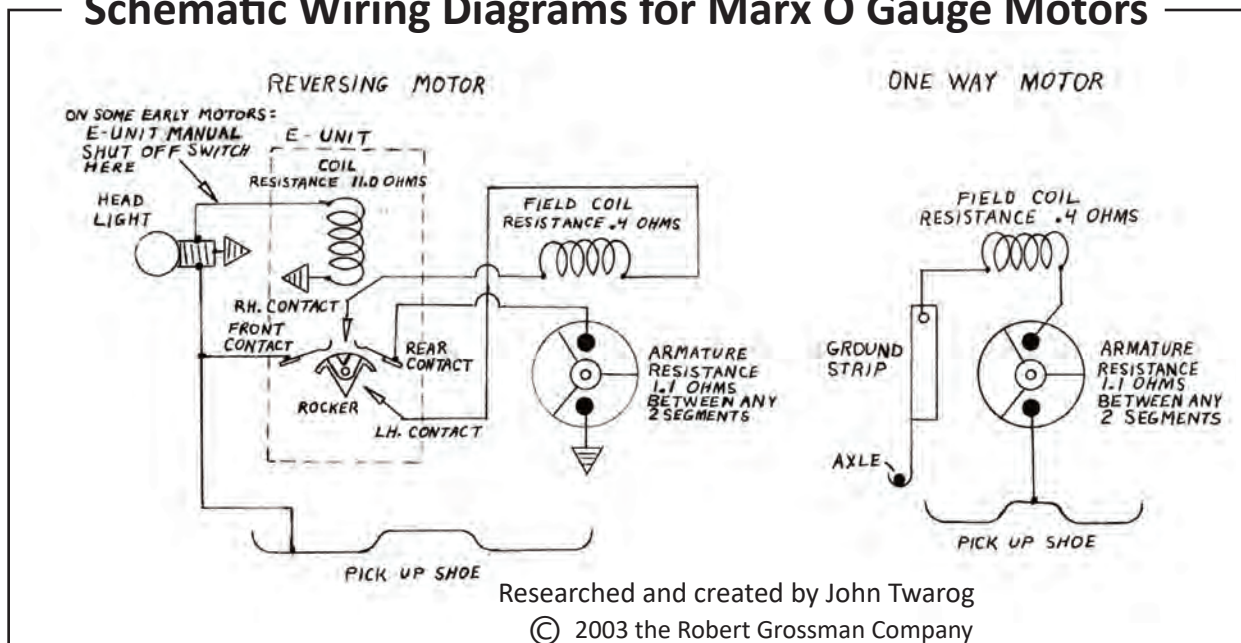

Motor Parts

Drivers

For non postwar *Baldwin* drivers call for availability.

338 Postwar *Baldwin* Driver

Specify:

- Plain
- Plain with post
- Geared
- Geared with post

For geared wheels, specify single or double reduction motors.

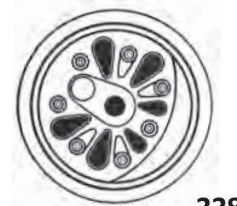

338

Side Rods (non-embossed)

2356LR Valve Gear Assemblies Crank and Rods for both sides of the engine. Includes attaching rivets



2356LR

237 333/1829 Plastic crank. Specify black or silver

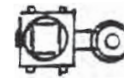

237

55 Crank Spacer for 333/1829 engines



55

247 Side Rod with Crosshead for 999 & *Canadian Pacific* engines



247

353 Guide for 247 Side Rod. Includes mounting eyelets

272 Straight Side Rod



272

310 666/1666 Side Rod with Pin for Smoke Unit

350 Solid Outer Steam Chest Side Rod for 1829 engine non-smoke



350



351

351 Inner Side Rod Wheel Link for 333/1829 engines

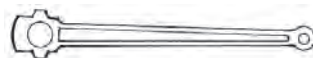

407

407 333/1829 Outer Side Rod

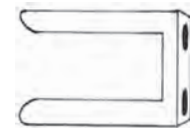

353

Rolling Stock

Couplers

16 **Plastic Knuckle Coupler** for 6" cars. Can be used on 4-wheel plastic with slight modifications

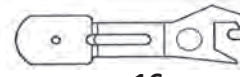

16

18 **Notched Plastic Tilt Automatic Coupler** for plastic E-7 diesels

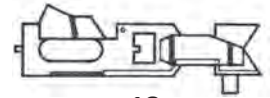

18

19 **Plastic Tilt Automatic Coupler**



19

58 **Scale Coupler Spring**



59



58

59 **Coupler Spring** for 18 and 19 couplers

109 **One-way Coupler spring**



109

133 **Joy Line Coupler**



223

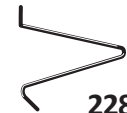

228

204 **Plastic Male Post** for pre-war one-way couplers

221 **Sliding Twist Type Tab & Slot Coupler** for wind up 6" 4 wheel frames

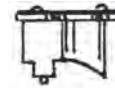

204



221

223 **Short Metal Tilt Coupler Spring**

227 **Tab and Slot Coupler** specify silver or black plating

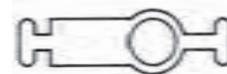

133



227

228 **Uncoupler Track Plate Spring**

244 **Metal Tilt Automatic Coupler** new or used (*good condition*)

497 **E-7 Tab Coupler** no slot for dummy A & B units



497



244

369 **Magnetic Uncoupling Adapter** Allows you to convert some Marx couplers into magnetic couplers to be used with the *Lionel* post-war magnetic uncoupling track. Clips onto existing Marx truck assembly.

Specify:

- Scale truck / Metal coupler
- Scale truck / Plastic coupler
- D,E,F,G truck / Plastic coupler



369

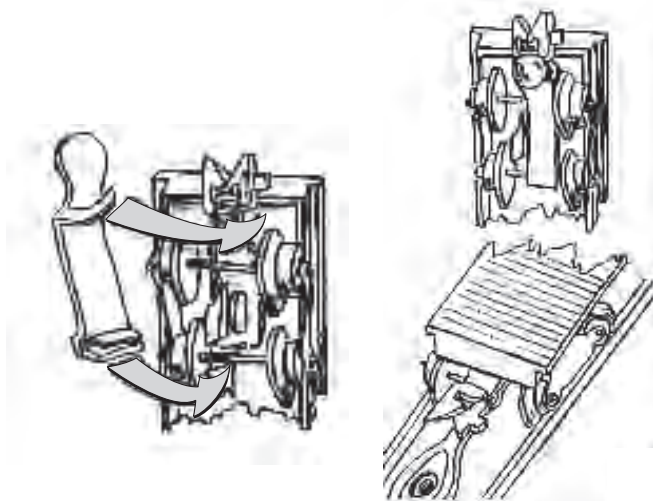

Rolling Stock

Loads

- 45 **Plastic Flatcar Railing** maroon, yellow, red, olive drab and white
- 74 **Silver Milk Can** 3 were used with some 555 C & S 6" reefers
- 362 **Brown Crate** for the plastic gondola. Also available with **USAX** military graphic (Sold individually, 4 per load)
- 346 **Black Wood Wheel** for metal vehicles used on the 562 6" flat car. Drill center hole to match axle.
- 460 **Large (.093) Axle** for the 346 wheel
- 463 **Small (.062) Axle** for the 346 wheel
- 76 **Searchlight Car** Silver
Made from original *Marx* dies. No *Marx* logo.
- 481 **White Tractor Trailer Doors** (pr)
- 484 **Hinge Pin** for the tractor trailer doors
- 485 **Burlington Nameplates** for the tractor trailer load (pr)
- 79 **12 Piece Chrome Pipe Load** for the 563 6" flatcar
- 83 **4 Piece Lumber Load** for 6" lumber car
- 84 **15 Piece Pole Load** for 6" pole car
- 85 **5 Piece Log Load** for *Erie* dump car
- 86 **Large 3 Piece Log Load** for deluxe flatcars
- 87 **Plastic Flat Car Lumber Load** square cut
- 88 **Plastic Flat Car Lumber Load** flat cut
- 89 **Scale Car Lumber Load**
- 03 **Studebaker Automobile.**
available in white, red, yellow, blue, green, gray, aqua, and beige
- 43 **Panel Truck**
available in white, red, yellow, green gray, and olive drab
- 326 **Double Vehicle Load Clip**
- 423 **Black Wheel Set** for auto and truck load
- 313 **Plastic Crate Cardboard Insert** used in the 20309 L & N gondola. Will fit any deluxe plastic gondola.

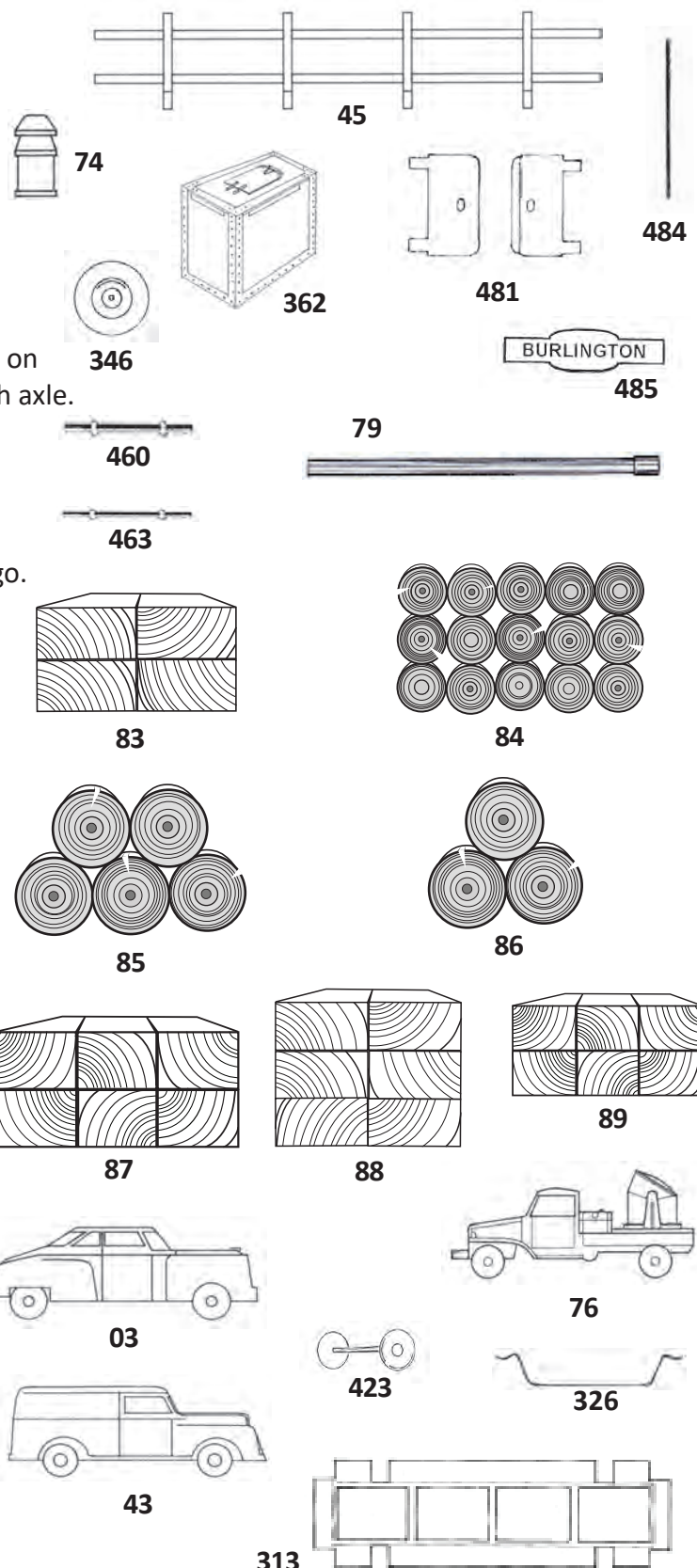

Rolling Stock

Loads

- 91 **Wooden Barrel** for the 6" barrel car
- 107 **Load Retainer** without springs
- 108 **Load Retainer** with springs
- 108A **Load Retainer Spring**
- 127 **Coal Load** for 6" hoppers
- 158 **Cardboard Insert** for the 548 Guernsey milk gondola
- 158A **Silver Wooden Milk Cans** for the 548 Guernsey gondola
- 159 **Toy Truck Spring Clip**
- 170 **Squatting Military Figure** gray plastic
- 175 **Cardboard Sewer Tile** for the L&N 20309 gondola
7 tiles will fit any plastic gondola
- 176 **8 Piece Cardboard Pipe Load**
- 177 **Load Tie Down** specify load type
- 181 **Black Wooden Cable Reel** with cord
for the 566 6" flat car
- 189 **White Cord** for the 566 6" cable reel flat car
- 208 **Nike Rocket**
specify aqua, beige, blue, green, gray,
metallic green, red, white or yellow
- 214 **Black Cardboard Ordnance Gondola Insert** for 6" car
- 215 **Silver Wooden Shell** for 6" car. 8 used with insert,
30 without insert
- 216 **Copper Wooden Shell** 8 used with insert
- 218 **Cardboard Nike Rocket Insert Loads**
- 263 **Plastic Cable Reel** specify gray or olive drab
- 311 **8 Piece Plastic Pipe Load**
used on the 44535 S.A.L. gray plastic flatcar
- 428 **Wire Hold Down** for cable reels (ea.)

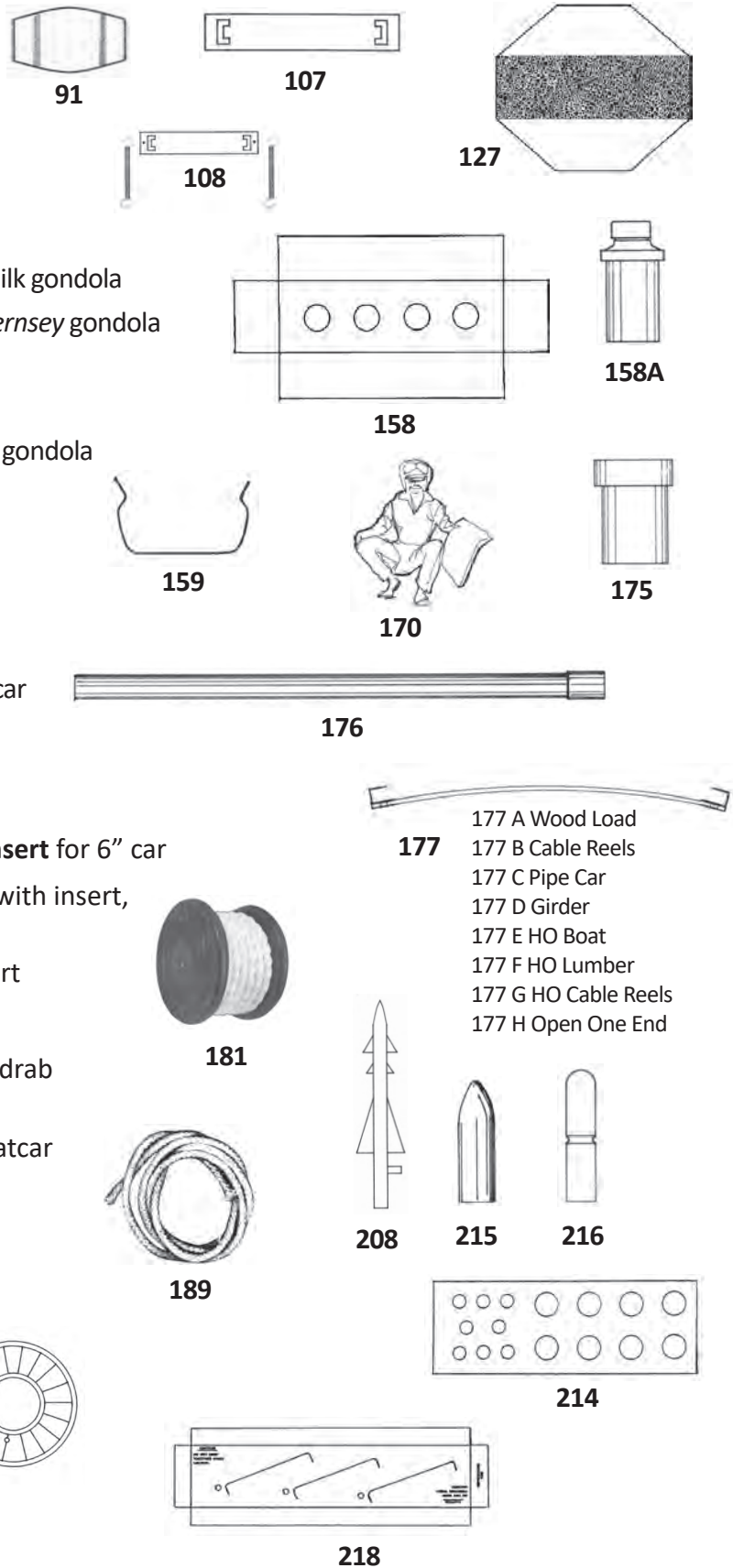

Rolling Stock

Passenger Cars

- 04 **Aerial Antenna** for the 572M 6" Army radio car
- 293 **Side Antennas** for the 572M 6" Army radio car
- 10 **Grab Iron** for 6" lighted passenger cars, brass or nickel
- 13 **Red Drum Head Lens** for 6" lighted observation cars
- 65 **Plastic Smoke Stack** for *Wm Crooks* pasenger cars and cabooses. Specify black, silver, white, red, tuscan red, orange, yellow, light green, dark green, jade green, olive drab, blue, brown, & tuscan brown
- 123 **Drum Head** for 11" observation cars
Specify:
 - 123 A- *Sante Fe*
 - 123 B- *Western Pacific*
 - 123 D- blue *New York Central*
- 184 **Lamp Cover** for the 6" observation car
- 239 **Light Bracket** for 11" passenger cars
- 249 **Plastic Railing** for *Wm Crooks* cars
- 250 **Metal Under-Frame Truss** for *Wm Crooks* cars
- 309 **Light Bracket** for 6" observation car
- 403 **Light Switch** for illuminated 6" cars
- 495 **7 1/4" Frame** will fit the *Wm Crooks* cars. Dark brown

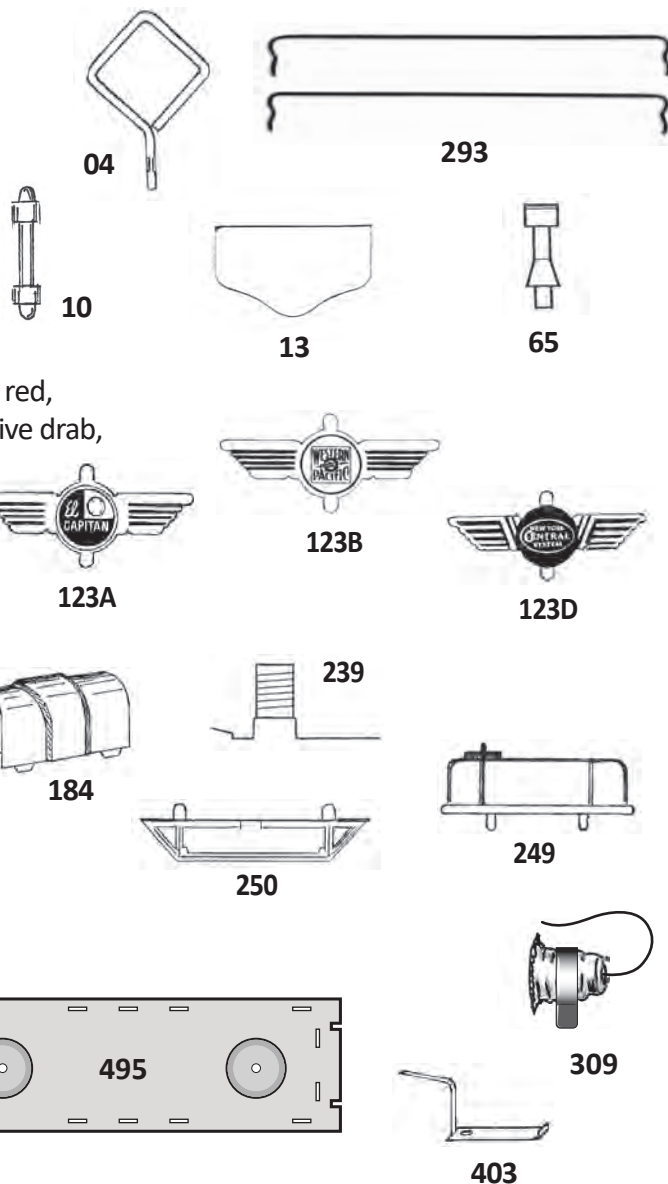

Truck Reference

Check for availability of new and used Truck Assemblies, Wheels, Couplers, and Axles

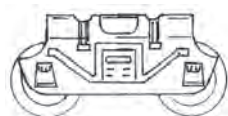

Type A



Type B



Type C

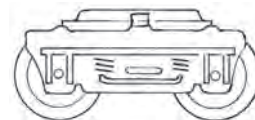

Type D



Type E

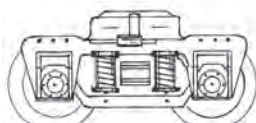

Type F



Type G

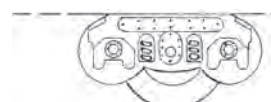

Type H

Rolling Stock

Freight Cars

- 26 Cast Metal Hook
- 36 Large Clear Searchlight Lens for gray or black plastic housing
- 36A Large Red Searchlight Lens for gray or black plastic housing
- 110 Crane Hook early wire type, specify copper or zinc
- 111A Short Return Spring for action cars, usually found on the bottom side of the frame
- 111B Long Return Spring used inside action cars and on the bottom of log dump cars
- 126 String for cast metal hook for the 550 wrecker crane
- 126A String for deluxe crane hook with pulley
- 156 Blue Action Boxcar Figure
- 178 Boom Support for plastic NYC crane
- 251 Metal Door Guide for scale and 7" boxcars
- 257 "New" Marx 7" & Scale Metal Boxcar Door miscellaneous colors available
- 273 Retaining Clip for *Erie* log dump car
- 286 Replacement Yoke, Housing and Base for the *G.A.E.X.* revolving searchlight car. This is a modified *Lionel* housing.
- 288 C Clip and Wave Spring for the 5590 deluxe crane
- 358B 6" Blank Door unpainted
- 364 6" Caboose Ladder and Railing used
- 393 Wedge Tender Weight
- 399 6" Wrecker Crane Roof also fits some metal derrick loaders
- 409 Nickel Floodlight used on the 6" 559 floodlight car and accessories
- 418 6" Door Guide unpainted
- 422 Main Spring for log dump car
- 455 Silver Insert for the metal dummy searchlight

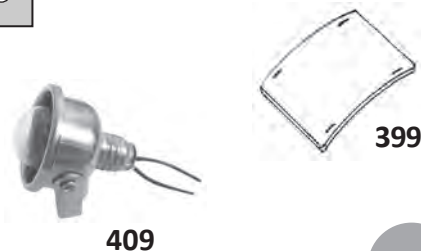
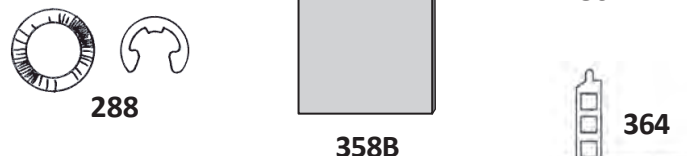
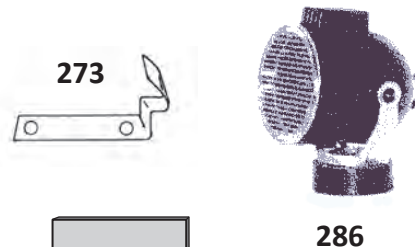
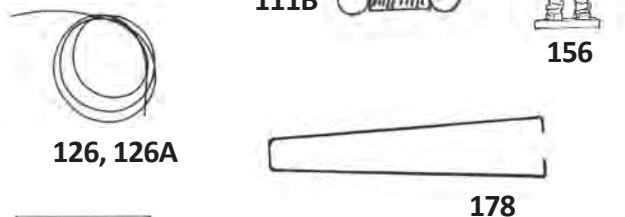
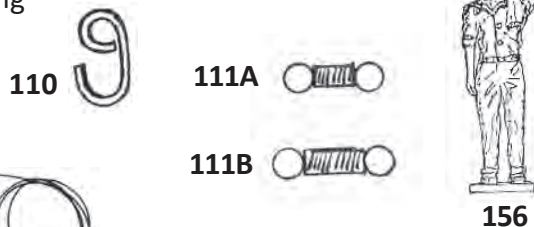
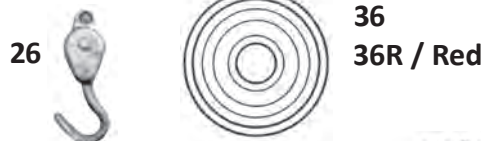

Rolling Stock

Freight Cars

- 01 Antenna bay window caboose
- 12 Brake Wheel for deluxe plastic cars
- 22 Plastic Boxcar Door available in white, red, tuscan red, green, olive drab, light blue, brown, chocolate brown, dark brown, and black
- 23 Action Boxcar Door with Post, white only
- 25 Gondola End available in black, silver, light blue, blue green, dark blue, tuscan red, brown, light orange, yellow, and mustard tan
- 134 Long Metal Door Guide for the *Seaboard* boxcars
- 136 Floodlight Car End Rails manufactured for the "new" Marx floodlight car. Ends can be cut to fit the original 6" floodlight cars.
- 161 Black Plastic Door Guide for plastic boxcar doors
- 284 Type F Truck Plastic Side Frame Used type E plastic sides frames should be available / inquire
- 312 Black 6" Dump Car Support Wires sold by the pair
- 420 Searchlight for the 5590 deluxe crane
- 427 Track Trip for all operating plastic action cars
- 431 Crank Handle for the NYC crane, available in gray or black
- 432 3 Piece Crank Assemble allows you to replace the whole assembly without splitting the boom

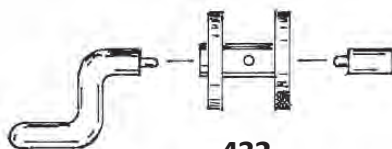
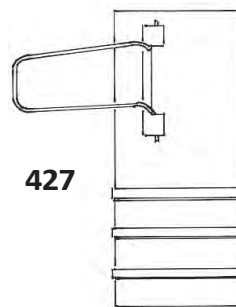
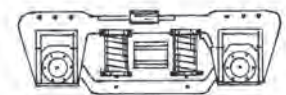
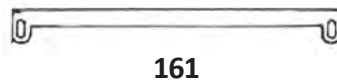
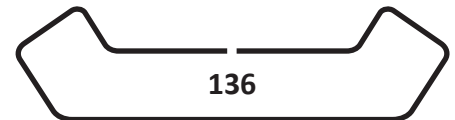
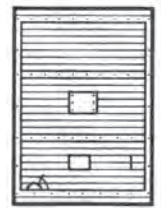
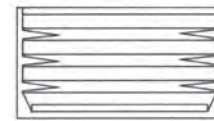
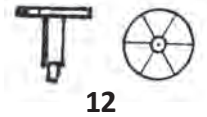
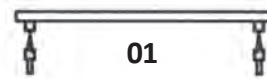

Rolling Stock



Pickup Assemblies

- 94 Pickup Assembly**
Specify type:
A-Flat sliding shoe, tab type with socket
B-Tab Type with Wire
C-Twist Type with Socket
D-Twist Type with Wire
E- Pickup assembly repair kit
Includes two shoulder rivets, two springs and two washers.

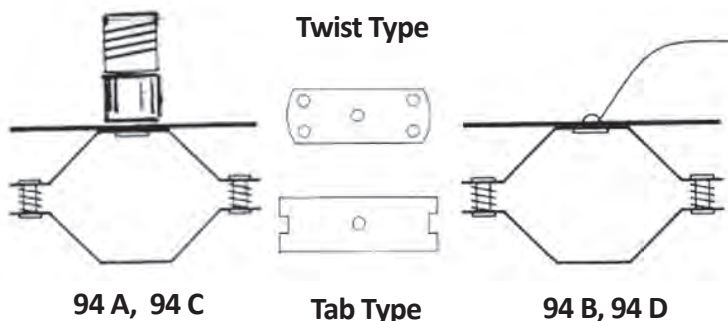

- 238 Scale Pickup Assembly** for type B & C trucks
262 Long Frame Pickup Assembly for type E, F, and G trucks
341 Pickup Spring for small sliding shoe
391 Prewar Pickup Shoe may require fitting

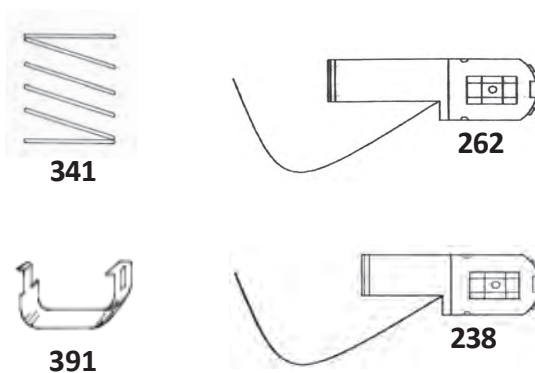

Axles, Trucks and Wheels

- 392 Axle** for 6" four wheel cars
404 Axle for Type B & C trucks
412 Scale Type B axle will also fit A, E & F trucks
413 Type G Axle. Will also fit Type D trucks, 6" & 7" cars
188 Truck Washer
195 3/16" Scale Wheels Black oxide. New
318 Wood Wheel for *Lumar Lines* Floor Trains
411 Large Wheel Black oxide. New
430 Wheel Set for the M10005 with 2 wheel motors. New black wheels
490 Small Front Pony Wheel for the tractor trailer (ea.)
491 Type G Trucks Pair of serviced, used trucks. Metal frame and wheels with plastic tilt couplers.
352 Scale Truck Side Frame Trim

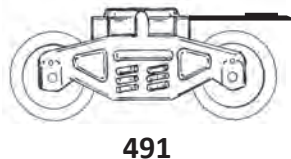
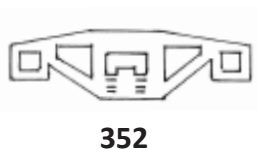
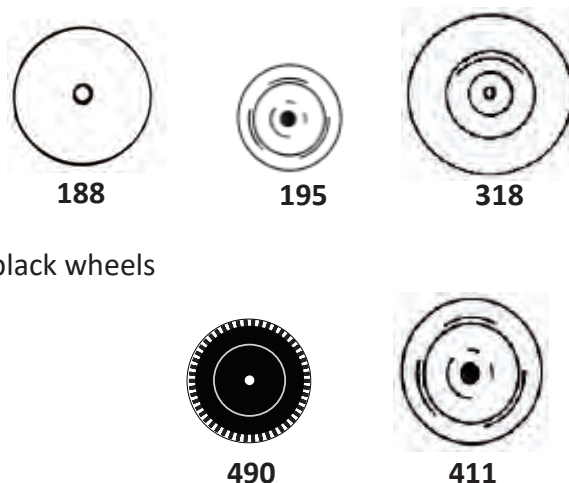





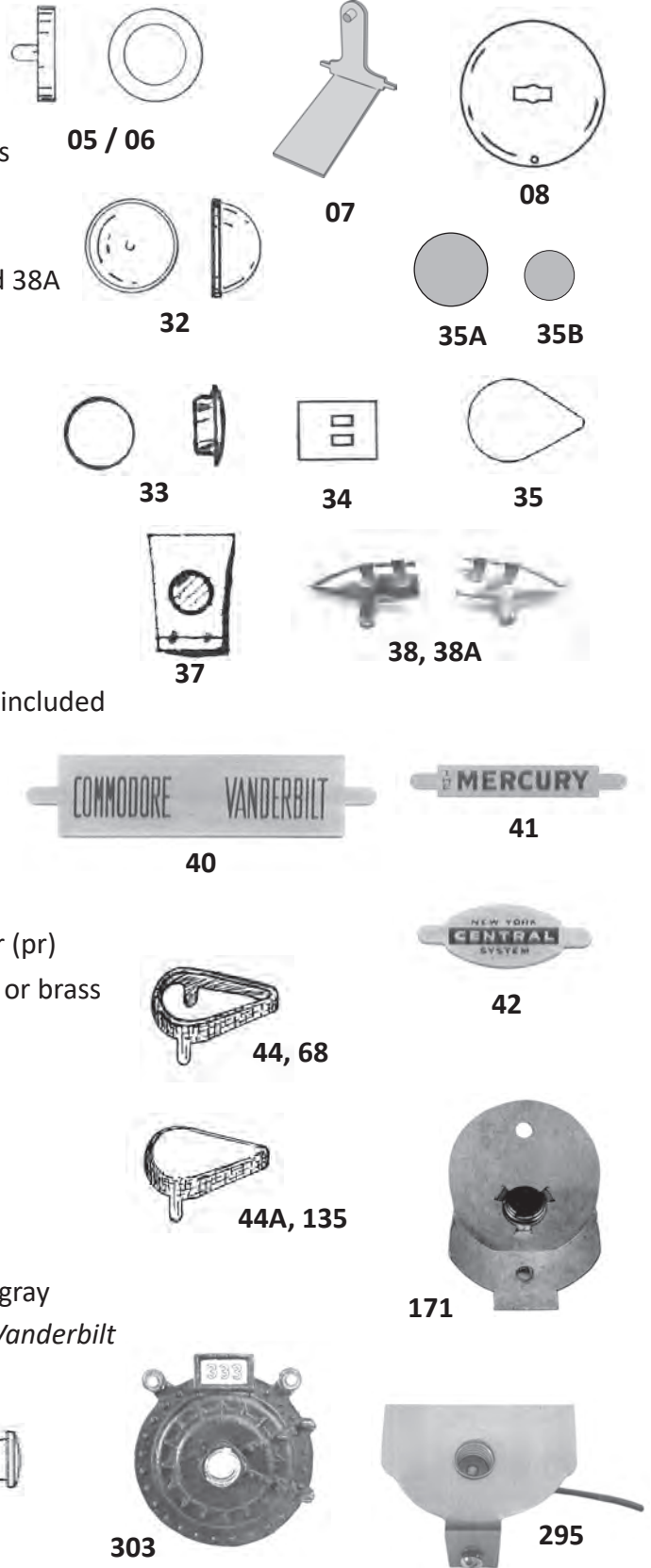

















Steam Engines

- 05 **Headlight Bezel** black metal
- 06 **Headlight Bezel** plastic, specify black or gray
- 07 **Sparkler Plate** for *Mercury* engines
- 08 **Postwar Boiler Front** for *Canadian Pacific* engines
- 32 **Headlight Lens** no dimples
- 33 **333 Marker Light lens** jade green
- 34 **Marker Light Lens** blue green for use with 38 and 38A
- 35 **Smoke Stack Lens** red or fluorescent orange
- 35A **Smoke Stack Lens** for 591, 897, 898, and 994 steam engines. Non-original
- 35B **Smoke Stack Lens** for pre-war *Canadian Pacific* engines with round stack. Non-original
- 37 **Boiler Front Marker Light** for early *Canadian Pacific* engines (pr)
- 38 **Plastic Steam Engine Marker Lights** specify gray or black (pr) Lens not included
- 38A **Metal Steam Engine Marker Lights** (pr) Lens not included
- 40 **Commodore Vanderbilt Nameplate** specify black, copper, or brass (pr)
- 40A **Commodore Vanderbilt Decal** Peel and stick. Specify black, brass or copper (pr)
- 41 **Mercury Nameplate** specify gray or copper (pr)
- 41A **Mercury Nameplate Decal** specify gray or copper (pr)
- 42 **Front Oval NYC Nameplate** specify black, copper or brass
- 42A **Front Oval NYC Decal** Peel and stick specify black, copper or brass
- 44 **Metal Streamlined Smokestack** for *Mercury* and *Commodore Vanderbilt* engines, open
- 44A **Metal Streamlined Smokestack** for *Mercury* and *Commodore Vanderbilt* engines, closed
- 68 **Plastic Streamlined Smokestack**, for *Mercury* or *Commodore Vanderbilt* engines. Specify black or gray
- 135 **Metal Streamlined Sand Dome** for *Commodore Vanderbilt* and *Mercury* Steam Engines
- 171 **333 Non-Smoke Lamp Plate**
- 295 **Mercury Lamp Plate**
- 303 **333 Boilerfront** complete
- 436 **Headlight Lens** turned down to fit 333, 999, 897/8 steam engines and others

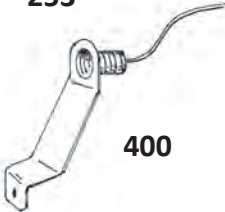
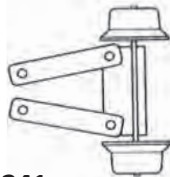
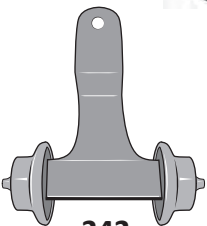

Steam Engines

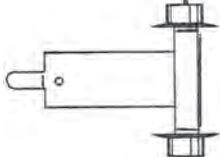
61	Plastic Round Sand Dome for <i>Canadian Pacific</i> engines, specify black or gray			
246	Metal Round Sand Dome for <i>Canadian Pacific</i> engines, black only			
		61, 246	66 / 245	
66	Plastic Round Smokestack for <i>Canadian Pacific</i> engines, specify black or gray			
245	Metal Round Smoke Stack for prewar <i>Canadian Pacific</i> engines, black only			
		72	162/3	
72	Traction Tire for grooved <i>Baldwin</i> driver			
162/3	Spring and Washer for the 4 wheel front truck			
219	Metal Bell for 666 engines, glue in place and paint, if desired			
		219	220	229
220	Bell Trim nickel plated with threads for easy installation. Includes nut			
222A	391 Number Board			
222B	396 Number Board			212
222C	397 Number Board			
222D	999 Number Board			
		222A	222B	222C
		222D		
212	Smoke Unit Top Insert for use with 666/1666 smoking engines			
			231	240
229	Cast Metal Weights for the <i>Canadian Pacific</i> engine			
231	Green Pin Type Marker Light Lens for early <i>Canadian Pacific</i> engines			
240	Smoke Stack Insert for 333 smoking engines			389
253	Boiler Front for prewar <i>Canadian Pacific</i> engines			
		253	255	
255	Front Pilot for <i>Canadian Pacific</i> engines. Nickel			
				259
259	Headlight Visor for the <i>Commodore Vanderbilt</i> engine. Black			
		400		
389	400 Puffer Smoke Stack Insert			
400	Light Bracket for <i>Commodore Vanderbilt</i> engines			
		241	242	
241	Front Truck for 999 or <i>Canadian Pacific</i> engines. Does not include the steam chest			
242	Rear Truck for <i>Canadian Pacific</i> engines.			
365	Front Truck for 666 / 1666 engines Not for use on locomotives with cylinder steam			365
416	Front Truck for 333, 1829, and <i>Wm. Crooks</i> engines			
		416		

Steam Engines

Decals

Decals are printed on clear die-cut vinyl unless otherwise indicated. Peel and stick.
Sold as pairs unless otherwise specified.

- 105 **William Crooks Engine Decals**
- 106 **William Crooks Tender Decal** specify
Tales of Wells Fargo or 1st Division St. Paul & Pacific
- 119 **Boiler Front Decal** for *Canadian Pacific* engines (ea)
- 120 **Intake Grill** for gray *Mercury* engines (ea)
- 121 **Army Supply Train Engine Sideboard Decal**
- 122 **Army Supply Train Tender Decal**
- 128 **Wedge Tender Decal** specify road name
- 130 **999 Engine and Tender**
- 131 **3991 Die Cast Tender**
- 143 **Canadian Pacific Side Board Decal** red and black.
Cut to shape
- 143A **Canadian Pacific 3000 Side Board Decal**
Maroon and yellow. Cut to shape
- 144 **Canadian Pacific 451/461 Tender Decal**
Specify maroon and yellow or silver and red.
Cut to shape
- 307 **Mercury Passenger Cars Decal Set** for tender,
observation and 3 cars. Does not include the stripes. 1/16" pin stripe tape
may be used. Includes 5 *NYC* pairs.
Specify black or white on die cut clear vinyl
- 445 **NYC Decal for the 551 6" tender** black on clear

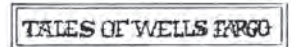

106



119



120



121



122

PENNSYLVANIA
SOUTHERN PACIFIC
READING
SANTA FE
NEW YORK CENTRAL
BALTIMORE & OHIO
SOUTHERN
CANADIAN PACIFIC

128



144



130



131



143



NEW YORK CENTRAL
NEW YORK CENTRAL

U.S.M.A.I.L. TOLEDO BAGGAGE CLEVELAND CHICAGO
U.S.M.A.I.L. TOLEDO BAGGAGE CLEVELAND CHICAGO
DETROIT EPWY DETROIT EPWY

307

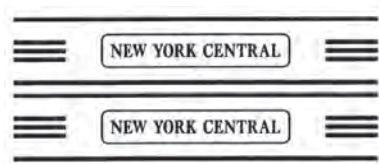

445

Steam Engines

Handrails

- 112 999, 898 Engines
- 113 666, 1666 Engines specify which type

114 Postwar *Canadian Pacific* Engines

115 *Mercury* Engines
specify stainless steel or copper

116 *Commodore Vanderbilt* Engines

117 333 Engines

124 Prewar *Canadian Pacific* Engines
does not include sand dome pipe

142 3991 Die Cast Tender

152 591 Engines

182 Cotter Pin

183 **Narrow Cotter Pin** used on 333 engines,
3991 cast tenders, and 2731 tenders

187 333 Cab Grab Iron

271 *William Crooks* Handrail Set

339 994 Engines

470 *GE 70 Ton Switcher*

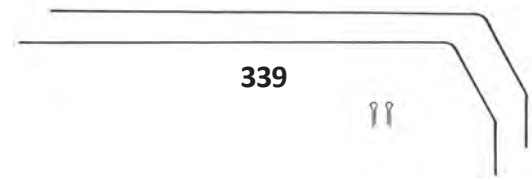
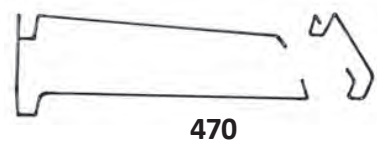
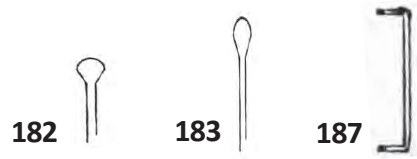
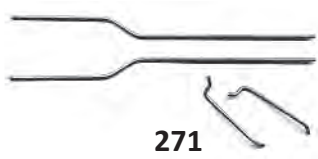
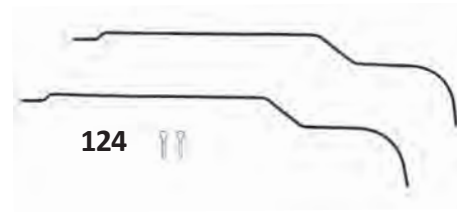
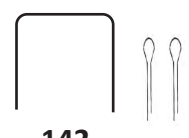
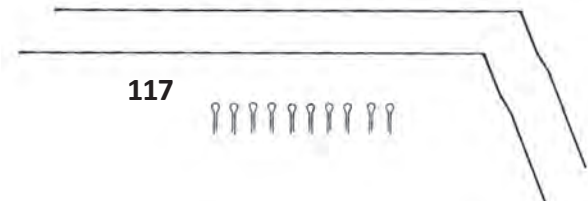
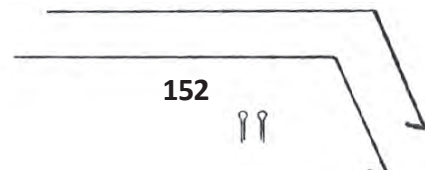
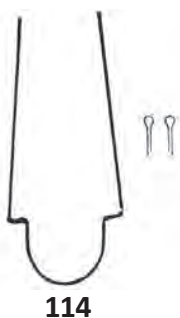
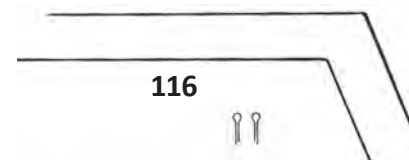
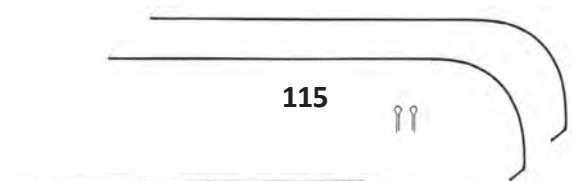
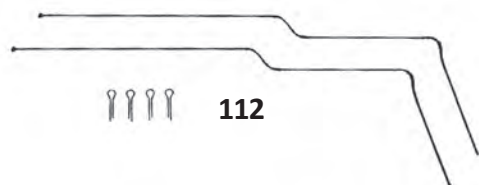

Tools

64 Needle Oiler



64

185 Wheel Puller

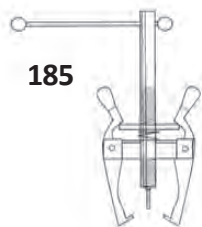

185

233 Large Size Eyelet Tool for setting #24 and #354 eyelets



233

260 Universal Flare Tool will set tiny eyelets



260

266 Tool Set For Bending Metal Tabs polished screwdriver for lifting, and wood sticks for bending them back down



333

289 Self Lubricating Plastic Razor Blades for cleaning a surface without scratching. (Pkg of 10)



289

296 Repair Kit for the Bubbling Water Tower includes support pieces for the tube and instructions



266

333 Small Size Eyelet Tool for the most common sizes

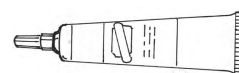

347

347 Lubriplate

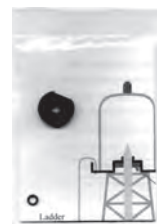

296

349 Post War Axle Bearing Puller styles may vary



349

363 O27 Track Pin Pliers for repairing rail ends

376 Motor Support Block Drive axles through the bearing. Remove front motor mount and turn side rods backward before using.



363

385 Bearing Tool, for driving bearings off axles

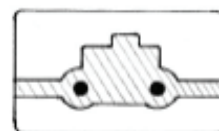

376

387 Coupler Eyelet Tool prevents eyelets from spinning when drilling out



385



387

395 Locking Hemostat for installing coupler springs

396 Screw Starter

465 Applicator for Smoke Oil



396



465



488



395



489

Marx: When Was It Made?



This page helps you identify the approximate manufacturing dates of your rolling stock or engine. While there are no confirmed records to rely on, these dates should serve as close estimates.



Rolling stock can be dated by truck type:

- | | |
|----------------------------|----------------------|
| A. 1937 -1942 | E. 1952 -1954 |
| B. 1941 -1946, 1954 | F. 1955 -1975 |
| C. 1949 -1954 | G. 1958 -1975 |
| D. 1950 -1956 | H. 1952 -1975 |

Diesel:

21 <i>Santa Fe</i>	1950 - 54
62 <i>Baltimore & Ohio</i>	1953 - 54, 1958, 1967
6000	1952 - 54
1998	1955 - 62
<i>Allstate E-7</i>	1957 - 59
99 <i>Rock Island E-7</i>	1958 - 74
99 <i>Rock Island E-7 B Unit</i>	1958- 61
901 <i>Western Pacific E-7</i>	1956 - 60
901 <i>Western Pacific E-7 B Unit</i>	1957 - 58
2002 <i>New Haven E-7</i>	1960 - 74
4000 <i>New York Central E-7</i>	1953 - 55, 59 - 69, 71 - 74
4000 <i>Penn Central E-7</i>	1971 - 73
1095 <i>Santa Fe E-7</i>	1955 - 71
54 <i>Kansas City Southern FM</i>	1956 - 60
81 <i>Monan FM</i>	1955 - 56, 1958 - 59
81 <i>Monan FM B Unit</i>	1958 - 59
112 <i>Lehigh Valley switcher</i>	1974 - 76
588 <i>New York Central switcher</i>	1958 - 62
702 <i>Western Pacific switcher</i>	1972 - 74
799 <i>Rock Island switcher</i>	1959 - 65
800 <i>Missouri Pacific switcher</i>	1975 - 76
2124 <i>Budd car</i>	1956 - 59

Steam:

<i>Commodore Vanderbilt</i>	1934 - 50
<i>Mercury</i>	1938 - 52
391 <i>Canadian Pacific</i>	1938 - 42
396 <i>Canadian Pacific</i>	1941 - 42
397 <i>Canadian Pacific</i>	1941
500 <i>Army Canadian Pacific</i>	1938 - 42
3000 <i>Canadian Pacific</i>	1939- 41, 1946 - 52
333	1949 - 58
666	1955 - 74
999	1946 - 59
994	1950 - 52
400	1952 - 58
490	1962 - 75
591	1953 - 58
898	1946 - 52
833	1952 - 54
1829	1953 - 59
1666	1960 - 74
<i>Wm. Crooks</i>	1959 - 62, 1973

Oct. 4, 1938.

R. V. KING

2,131,877

REVERSING AND LOCKING MECHANISM FOR SPRING MOTOR TOYS

Filed Jan. 28, 1936

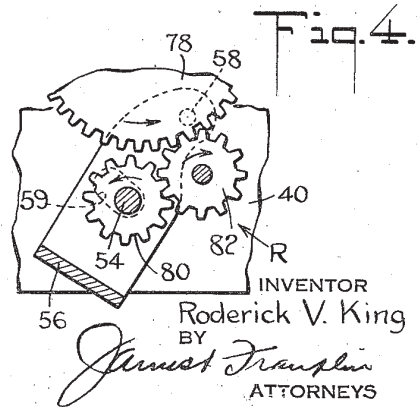
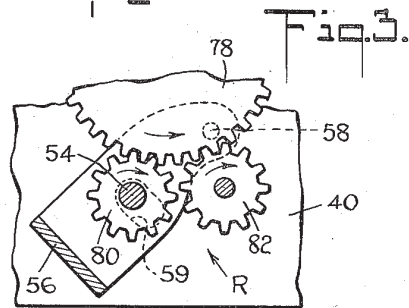
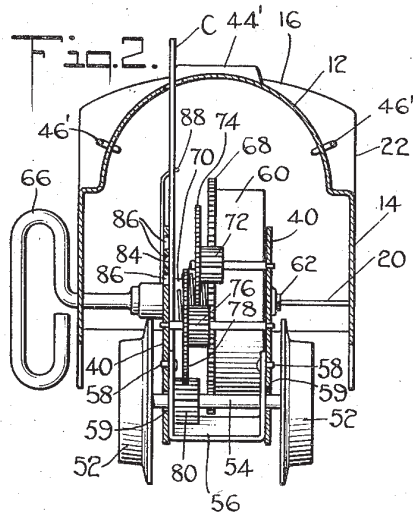
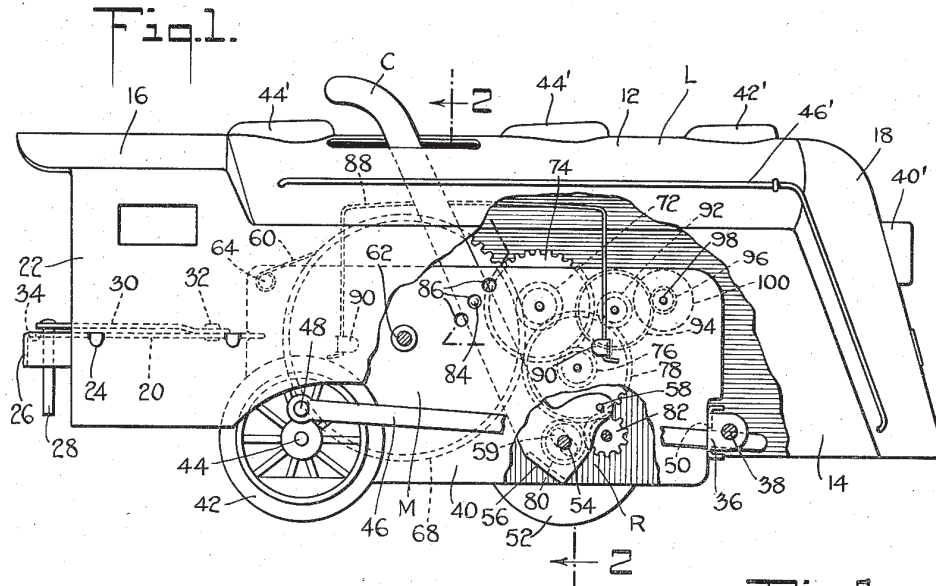

Thank you for shopping with the Robert Grossman Company!